



100%

SPRING 2013

CONTENT

Goggles:

The Racecraft Page 10-15

The Accuri Page 18-25

The Strata Page 26-29

The Accuri Jr Page 30-31

Replacement Lenses: Page 34-37

Goggle Accessories: Page 40-41

Sunglasses: Page 42-45

Casual: Page 46-49

Collectibles: Page 50-51

Overview: Page 52-53





MARVIN
MUSQUIN



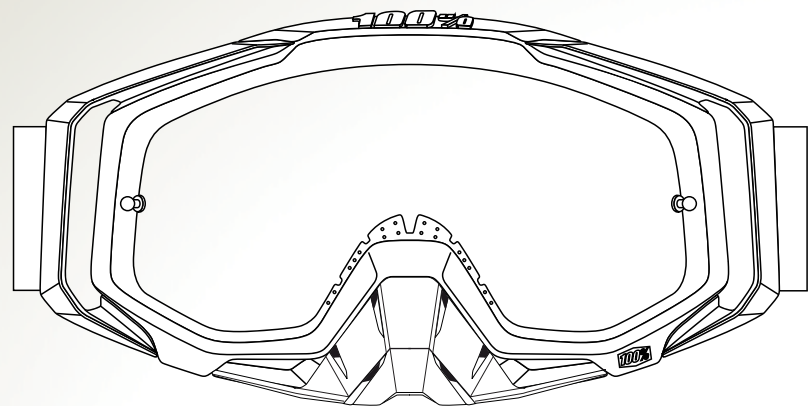

THE RACECRAFT

MSRP: \$65 - \$75

Page 12-17

The premier 100% line of goggle system represents our commitment to create an enhanced user experience, by providing riders with a higher level of functionality and accurate vision. The Racecraft is a synthesis of precision engineering and minimal design, which produces a goggle that performs and feels as great as it looks.

-  **1. Outriggers:**
Helping to achieve perfect fit and balance.
-  **2. Removable nose guard:**
The attachment of the 100% nose guard is a unique incorporation of the frame co-molding to insure stability and protection in the most testing conditions.
-  **3. Foam:**
Thirsty triple layer moisture managing foam.
-  **4. Lens:**
Anti-fog coated Lexan lens for flawless vision. Shares the same lens shape across the product line.
-  **5. Strap:**
45mm wide, Silicon coated strap eliminates slippage.
-  **6. Co-molding:**
This feature allows the incorporation of patent pending technologies into the frame while still holding 100% performance and styling true.
-  **7. Air intakes:**
Patent pending technology channels air into the foam, aiding in moisture management.
-  **8. In the box:**
Mirrored Lens models include: 20 standard tear-off's, an extra clear lens, and a sublimated microfiber bag.
Clear Lens models include: 20 standard tear-off's and a sublimated microfiber bag.

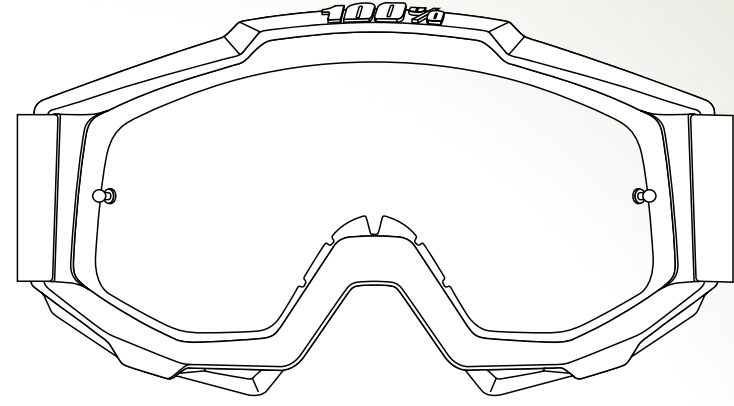







THE ACCURI

MSRP: \$45 - \$60

Page 20-23

Focus, a point at which an object must be situated with respect to a lens for an image to be well defined. A thin lens is all that stands in your way when you are focused. The Accuri can silently help you focus on your competition, enabling you the opportunity to leave it all on the track.

-  **1. Simplicity:**
All 100% MX goggles share the same lens and tear-off profile.
-  **2. Foam:**
Moisture managing triple layer foam.
-  **3. Frame:**
Constructed out of flexible yet durable urethane.
-  **4. Lens:**
Comes equipped with anti-fog, scratch resistant Lexan® lens for unimpaired vision. Shares the same lens shape across the product line.
-  **5. Strap:**
Oversized 45mm silicon coated strap holds your goggles motionless.
-  **6. Fitment:**
Curvature suited for comfort.
-  **7. In the Box:**
Mirrored and Smoke Lens models include an additional clear lens and a soft microfiber bag for cleaning and storage.
Clear Lens models include: A soft microfiber bag for cleaning and storage.

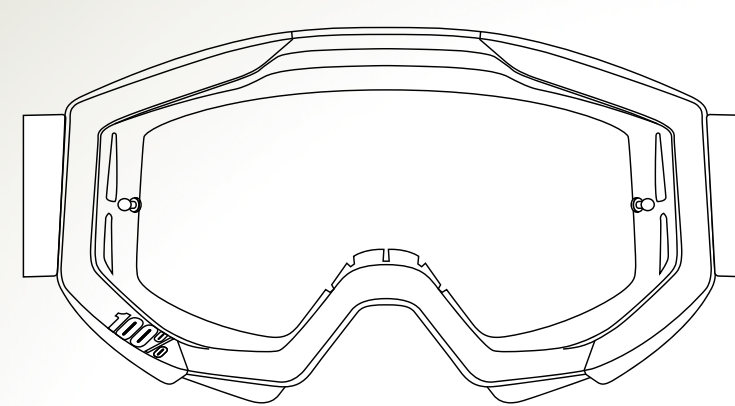







THE STRATA

MSRP: \$30

Page 24-27

The Strata. Lead the charge. Purpose built for exceptional performance and comfort, the Strata arms you with high-end features at a value that enables you to put in those extra laps.

-  **1. Simplicity:**
All 100% MX goggles share the same lens and tear-off profile.
-  **2. Fitment:**
Curvature suited for comfort and an exceptional fit.
-  **2. Foam:**
Plush, Dual-Layered face foam soaks up sweat.
-  **3. Frame:**
Constructed out of flexible yet durable urethane featuring combined matte and gloss finish.
-  **4. Lens:**
Anti-fog, scratch resistant Lexan® lens for unimpaired vision complete with tear-off pins. Shares the same lens shape across the product line.
-  **5. Strap:**
40mm silicon coated strap holds your goggles in place.
-  **6. In the Box:**
A free microfiber bag for cleaning and storage.

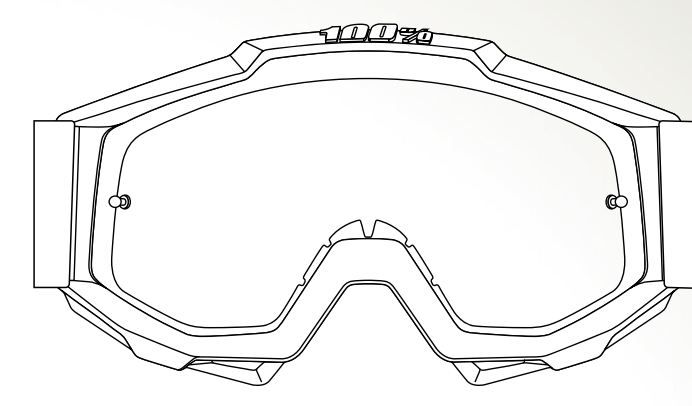







THE ACCURI JR

MSRP: \$35 - \$45

Page 28-29

Dynamite comes in small packages. The Accuri Jr. is a potent little goggle packed with the same high performance features as the adult version, youth-specific designed to perfectly fit young guns. Performance and protection you can count on for the most serious riders on the track.

-  **1. Simplicity:**
The most advanced form of simple. Sharing the same features as the adult goggle.
-  **2. Fitment:**
Curvature suited for comfort and specifically developed for youth.
-  **Foam:**
Moisture managing triple layer foam.
-  **3. Frame:**
Constructed out of flexible yet durable urethane.
-  **4. Lens:**
Equipped with an anti-fog scratch resistant lens for unimpaired vision.
-  **5. Strap:**
Oversized 45mm silicon coated strap holds your goggles motionless.

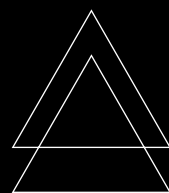

THE PURPLE MAIN



THE RACECRAFT *Purple Main - Silver Mirror lens*

New Mirror Lens: # 50110-053-02 PU #: 26011711
Clear Lens: # 50100-053-02 PU #: 26011714



THE RACECRAFT *Metal Black Lime - Blue Mirror lens*

New Mirror Lens: # 50110-027-02 PU #: 26011710
Clear Lens: # 50100-027-02 PU #: 26011713



THE RACECRAFT *Terminator - Red Mirror lens*

New Mirror Lens: # 50110-055-02 PU #: 26011712
Clear Lens: # 50100-055-02 PU #: 26011715

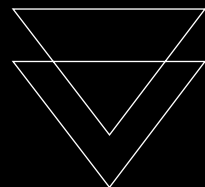

THE TERMINATOR



THE RACECRAFT *Mandarina - Mirror Gold lens*

Mirror Lens: # 50110-006-02 PU #: 26011484
Clear Lens: # 50100-006-02 PU #: 26011489



THE RACECRAFT *Racing Tuxedo - Mirror Silver lens*

Mirror Lens: # 50110-043-02 PU #: 26011486
Clear Lens: # 50100-043-02 PU #: 26011491



THE RACECRAFT *Kaleidoscope - Mirror Silver lens*

Mirror Lens: # 50110-045-02 PU #: 26011488
Clear Lens: # 50100-045-02 PU #: 26011493



THE RACECRAFT *Supersonic - Mirror Silver lens*

Mirror Lens: # 50110-044-02 PU #: 26011487
Clear Lens: # 50100-044-02 PU #: 26011492



THE RACECRAFT *Varsity - Silver Mirror lens*

Mirror Lens: # 50110-032-02 PU #: 26011425
Clear Lens: # 50100-032-02 PU #: 26011434



THE RACECRAFT *Gunmetal / Carbon - Mirror Blue lens*

Mirror Lens: # 50110-025-02 PU #: 26011485
Clear Lens: # 50100-025-02 PU #: 26011490



THE METAL BLACK-LIME



THE RACECRAFT *Black / White - Mirror Gold lens*

Mirror Lens: # 50110-011-02 PU #: 26011421
Clear Lens: # 50100-011-02 PU #: 26011430



THE RACECRAFT *Blue / White - Mirror Blue lens*

Mirror Lens: # 50110-022-02 PU #: 26011420
Clear Lens: # 50100-022-02 PU #: 26011429



THE RACECRAFT *Black / Red - Mirror Silver lens*

Mirror Lens: # 50110-013-02 PU #: 26011423
Clear Lens: # 50100-013-02 PU #: 26011432



THE RACECRAFT *Black / Yellow - Smoke lens*

Mirror Lens: # 50110-014-02 PU #: 26011422
Clear Lens: # 50100-014-02 PU #: 26011431



THE RACECRAFT *Orange Destruct - Silver Mirror lens*

Mirror Lens: # 50110-036-02 PU #: 26011428
Clear Lens: # 50100-036-02 PU #: 26011437



THE RACECRAFT *Red Destruct - Red Mirror lens*

Mirror Lens: # 50110-037-02 PU #: 26011427
Clear Lens: # 50100-037-02 PU #: 26011436



HOW MUCH EFFORT DO YOU GIVE?

Mike Sleeter spends countless hours on the track analyzing every detail while developing and testing to improve product performance.





 THE CALTRANS



THE ACCURI *90's Galore - Gold Mirror lens*

New Mirror Lens: # 50210-056-02 PU #: 26011718
 Clear Lens: # 50200-056-02 PU #: 26011722



THE ACCURI *Slimy - Blue Mirror lens*

New Mirror Lens: # 50210-027-02 PU #: 26011716
 Clear Lens: # 50200-027-02 PU #: 26011720



THE ACCURI *Caltrans - Silver Mirror lens*

New Mirror Lens: # 50210-054-02 PU #: 26011717
 Clear Lens: # 50200-054-02 PU #: 26011721



THE ROLLERBALL



LIMITED EDITION



THE ACCURI

Rollerball - Silver Mirror lens

New Mirror Lens: # 50210-057-02 PU #: 26011719
Clear Lens: # 50200-057-02 PU #: 26011723



 THE SLIMY



THE ACCURI *Camosquito - Gold Mirror lens*

Mirror Lens: # 50210-042-02 PU #: 26011498
Clear Lens: # 50200-042-02 PU #: 26011503



THE ACCURI *Graph - Silver Mirror lens*

Mirror Lens: # 50210-041-02 PU #: 26011497
Clear Lens: # 50200-041-02 PU #: 26011502



THE ACCURI *Reflex Blue - Blue Mirror lens*

Mirror Lens: # 50210-002-02 PU #: 26011494
Clear Lens: # 50200-002-02 PU #: 26011499



THE ACCURI *Gunmetal - Red Mirror lens*

Mirror Lens: # 50210-025-02 PU #: 26011495
Clear Lens: # 50200-025-02 PU #: 26011500



THE ACCURI *Fluo Yellow - Red Mirror lens*

Mirror Lens: # 50210-004-02 PU #: 26011444
Clear Lens: # 50200-004-02 PU #: 26011453



THE ACCURI *Subway - Green Mirror lens*

Mirror Lens: # 50210-039-02 PU #: 26011496
Clear Lens: # 50200-039-02 PU #: 26011501



 THE 90'S GALORE



THE ACCURI *Black / Cyan - Blue Mirror lens*

Mirror Lens: # 50210-012-02 PU #: 26011443
Clear Lens: # 50200-012-02 PU #: 26011452



THE ACCURI *Red - Red Mirror lens*

Mirror Lens: # 50210-003-02 PU #: 26011442
Clear Lens: # 50200-003-02 PU #: 26011451



THE ACCURI *White / Red - Blue Mirror lens*

Mirror Lens: # 50210-020-02 PU #: 26011441
Clear Lens: # 50200-020-02 PU #: 26011450



THE ACCURI *Pure Black - Silver Mirror lens*

Mirror Lens: # 50210-001-02 PU #: 26011440
Clear Lens: # 50200-001-02 PU #: 26011449



Black Enduro - Dual Vented lens

THE ACCURI *Pure Black Enduro - Dual Vented lens*

Sand Model with closed foam: # 50201-001-02 PU #: 26011446
Enduro Model with dual vented lens: # 50202-001-02 PU #: 26011445

ANTOINE
MEO



THE STRATA



THE STRATA *Black / Lime - Clear lens*

Clear Lens: # 50400-027-02 PU #: 26011515



THE STRATA *Blue Lagoon - Clear lens*

Clear Lens: # 50400-002-02 PU #: 26011512



THE STRATA *Fire Red - Clear lens*

Clear Lens: # 50400-003-02 PU #: 26011513



THE STRATA *Sunny Days - Clear lens*

Clear Lens: # 50400-029-02 PU #: 26011517



THE STRATA *Ice Age - Clear lens*

Clear Lens: # 50400-028-02 PU #: 26011516



THE STRATA *Black / Mandarinina - Clear lens*

Clear Lens: # 50400-026-02 PU #: 26011514



THE STRATA *Suit - Clear lens*

Clear Lens: # 50400-035-02 PU #: 26011519



THE STRATA *Boss - Clear lens*

Clear Lens: # 50400-047-02 PU #: 26011520



THE STRATA *Frisbee - Clear lens*

Clear Lens: # 50400-048-02 PU #: 26011521



THE STRATA *Skelter - Clear lens*

Clear Lens: # 50400-034-02 PU #: 26011518

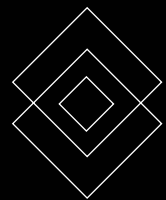

THE ACCURI JR CHEETAH



THE ACCURI JUNIOR

Black - Silver Mirror lens

Mirror Lens: # 50310-001-02 PU #: 26011504
Clear Lens: # 50300-001-02 PU #: 26011508



THE ACCURI JUNIOR

Graph - Silver Mirror lens

Mirror Lens: # 50310-041-02 PU #: 26011507
Clear Lens: # 50300-041-02 PU #: 26011511



THE ACCURI JUNIOR

Cheetah - Silver Mirror lens

Mirror Lens: # 50310-038-02 PU #: 26011505
Clear Lens: # 50300-038-02 PU #: 26011509



THE ACCURI JUNIOR

Subway - Green Mirror lens

Mirror Lens: # 50310-039-02 PU #: 26011506
Clear Lens: # 50300-039-02 PU #: 26011510

TRY ME!

*In MX, vision is everything. No matter how prepared you are,
if you end up with dirt bouncing around inside your goggles, you KNOW
it's just a matter of time before it's either in your eye or it forces you to lose focus.
With the new Racecraft, thanks to its unique shape & three layer contour foam, those days are over.
Now you can give 100% of your concentration on what you do best
.....no matter what comes at you.*



SIMPLICITY IS THE ULTIMATE SOPHISTICATION



From the premier line of 100% goggles, come the Racecraft, the Accuri and the Strata. While all models offer unique features, fit and function, they all carry the same DNA & utilize the same interchangeable TOPVIEW® lens technology and tear-off system. Be prepared for any riding conditions while stocking your gear bag with less accessories. 100%, the most versatile goggle system in motocross.



LENSES



CLEAR

51001-010-02 PU #: 2602-0480

All purpose lens provides maximum amount of light allowance for all conditions.



SMOKE

51001-007-02 PU #: 2602-0483

Neutral tint reduces glare while providing accurate color perception in medium to bright light conditions.



PERSIMMON

51001-046-02 PU #: 2602-0485

Ideal for overcast conditions. Depth perception is improved with increased contrast.



ORANGE

51001-006-02 PU #: 2602-0484

Increased depth perception and contrast. Great for overcast conditions.



YELLOW

51001-004-02 PU #: 2602-0482

Perfect for flat, low light conditions. This lens improves the contrast and definition of any obstacle you encounter.



BLUE

51001-002-02 PU #: 2602-0481

Increased contrast for varying conditions. Ideal for medium to low light.



BLUE MIRROR

51002-002-02 PU #: 2602-0488

Mirrored finish offers the maximum reduction of glare in bright light conditions for improved performance and visibility.



GOLD MIRROR

51002-009-02 PU #: 2602-0491

Mirrored finish offers the maximum reduction of glare in bright light conditions for improved performance and visibility.



RED MIRROR

51002-003-02 PU #: 2602-0490

Mirrored finish offers the maximum reduction of glare in bright light conditions for improved performance and visibility.



SILVER MIRROR

51002-008-02 PU #: 2602-0487

Mirrored finish offers the maximum reduction of glare in bright light conditions for improved performance and visibility.



GREEN MIRROR

51002-005-02 PU #: 2602-0489

Mirrored finish offers the maximum reduction of glare in bright light conditions for improved performance and visibility.



CLEAR DUAL

51005-010-02 PU #: 2602-0495

Dual lens for the toughest conditions. Prevents fog build up in all weather conditions.



SMOKE DUAL

51005-007-02 PU #: 2602-0496

Dual lens for the toughest conditions. Prevents fog build up in all weather conditions.



CLEAR VENTED DUAL

51006-010-02 PU #: 2602-0506

Prevents fog build up in all weather conditions. All purpose lens provides maximum amount of light allowance for all conditions.



SMOKE VENTED DUAL

51006-007-02 PU #: 2602-0505

Neutral tint reduces glare in medium to bright light conditions. Prevents fog build up in all weather conditions.



YELLOW VENTED DUAL

51006-004-02 PU #: 2602-0504

Perfect for flat, low light conditions. This lens improves the contrast and definition. Prevents fog build up in all weather conditions.



BLUE VENTED DUAL

51006-002-02 PU #: 2602-0503

Increased contrast for varying conditions. Ideal for medium to low light. Dual lens prevents fog build up in all weather conditions.



PERSIMMON VENTED DUAL

51006-046-02 PU #: 2602-0508

Prevents fog build up in all weather conditions. Ideal for overcast conditions. Depth perception is improved with increased contrast.



ROSE VENTED DUAL

51006-016-02 PU #: 2602-0507

Increased depth perception and contrast. Great for overcast conditions. Prevents fog build up in all weather conditions.



RED MIR. VENTED DUAL

51006-003-02 PU #: 2602-0510

Prevents fog build up in all weather conditions. Mirrored finish offers the maximum reduction of glare in bright light conditions for improved performance and visibility.



SILVER MIR. VENTED DUAL

51006-008-02 PU #: 2602-0512

Prevents fog build up in all weather conditions. Mirrored finish offers the maximum reduction of glare in bright light conditions for improved performance and visibility.



BLUE MIR. VENTED DUAL

51006-022-02 PU #: 2602-0509

Prevents fog build up in all weather conditions. Mirrored finish offers the maximum reduction of glare in bright light conditions for improved performance and visibility.



GOLD MIR. VENTED DUAL

51006-009-02 PU #: 2602-0513

Prevents fog build up in all weather conditions. Mirrored finish offers the maximum reduction of glare in bright light conditions for improved performance and visibility.



GREEN MIR. VENTED DUAL

51006-005-02 PU #: 2602-0511

Prevents fog build up in all weather conditions. Mirrored finish offers the maximum reduction of glare in bright light conditions for improved performance and visibility.



YOUTH CLEAR

51003-010-02 PU #: 2602-0516

All purpose lens provides maximum amount of light allowance for all conditions.



YOUTH SMOKE

51003-007-02 PU #: 2602-0517

Neutral tint reduces glare while providing accurate color perception in medium to bright light conditions.



YOUTH SILVER MIRROR

51003-008-02 PU #: 2602-0518

Mirrored finish offers the maximum reduction of glare in bright light conditions for improved performance.



YOUTH GREEN MIRROR

51003-005-02 PU #: 2602-0519

Mirrored finish offers the maximum reduction of glare in bright light conditions for improved performance and visibility.



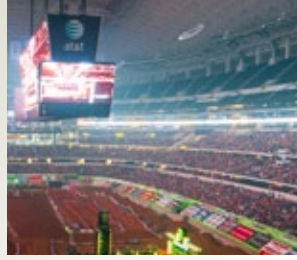

ACCESSORIES



LAMINATED TEAR OFFS # 51010-010-02 PU#: 2602-0497

Extremely thin laminated tear off's provide maximum clarity with reduced layers of film. Fit all Racecraft, Accuri and Strata goggles. 2 packs of 7.

STANDARD TEAR OFFS # 51011-010-02 PU#: 2602-0498

Get clear vision with a simple pull of the tab. Tear Off's fit all Racecraft, Accuri and Strata goggles. Pack of 20.

YOUTH TEAR OFFS # 51012-010-02 PU#: 2602-0521

Get clear vision with a simple pull of the tab. Tear Off's fit only the Accuri Jr goggle. Pack of 20.



TEAR OFF STRAP PINS # 51013-001-02 PU#: 2602-0520

Attach to goggle straps for perfect alignment of tear-off's. Pack of 3



REPLACEMENT LENS # 51021-010-02 PU#: 2602-0493

Clear replacement lens with mounting holes for use with Speedlab Vision System. Fits all Accuri and Strata goggles.



SPEEDLAB FILMS # 51022-010-02 PU#: 2602-0494

Replacement film canisters for use with the Speedlab Vision System. Pack of 6



MUDFLAP KIT # 51023-010-02 PU#: 2602-0499

Prevents water, dirt, mud and other elements from infiltrating the Speedlab Vision System. Pack of 3



SPEEDLAB VISION SYSTEM # 51020-010-02 PU#: 2602-0492

Retain clear vision in the most treacherous conditions. The Speedlab Vision System arms you with 25-30 clear views in this easy to use system. Fits all Accuri goggles. Complete set includes: 1 Lens, 2 Canisters, and a Mud Flap.



REPLACEMENT NOSE GUARD

Black: #51031-001-02 PU#: 2602-0515 White: #51031-000-02 PU#: 2602-0514

A simple attachment of the the 100% nose guard provides increased protection. Fits Racecraft models only.



Destin Cantrell
THE BOWEN

SUNGLASSES



60004-001-01
 PU#: 2601-0779

THE ATSUTA *Gloss Black - Grey tint lens*



60005-024-01
 PU#: 2601-0784

THE BOWEN *Gloss Black / Tortoise - Grey Gradient lens*

*Black / Purple
 Purple Mirror lens
 # 60004-050-01
 PU#: 2601-0778*



*Black / Red
 Grey tint lens
 # 60005-013-01
 PU#: 2601-0782*



*Clear / Orange
 Orange Mirror lens
 # 60004-049-01
 PU#: 2601-0781*



*Matte Black / White
 Grey Gradient lens
 # 60005-011-01
 PU#: 2601-0783*



*Translucent Blue / White
 Grey tint lens
 # 60004-051-01
 PU#: 2601-0780*



SUNGLASSES



60001-014-01
PU#: 2601-0785

THE BURGETT *Gloss Black / Gold - Grey tint lens*



60003-024-01
PU#: 2601-0794

THE HEIKKI *Tortoise - Brown tint lens*



60002-013-01
PU#: 2601-0789

THE HAKAN *Matte Black / Red - Grey tint lens*

*Matte Black / White
Grey tint lens*
60001-011-01
PU#: 2601-0786



*Dark Tortoise
Grey tint lens*
60001-024-01
PU#: 2601-0787



*Gloss Black / Silver
Grey tint lens*
60003-001-01
PU#: 2601-0791



*Matte Primer
Grey tint lens*
60003-023-01
PU#: 2601-0792



*Matte Black / Black
Grey tint lens*
60003-019-01
PU#: 2601-0793



*Gold / Black
Bronze tint lens*
60002-009-01
PU#: 2601-0790



*Brushed Silver / Grey
Grey Gradient lens*
60002-008-01
PU#: 2601-0788



CASUAL



MACHINE

Heather Grey Flexfit

C/Note S-M: # 20020-007-17 PU #: 2501-1725
L-XL: # 20020-007-18 PU #: 2501-1726

MACHINE

Black Snapback

C/Note # 20021-001-01 PU #: 2501-1727



ELLIS

Black Trucker

C/Note # 20018-001-01 PU #: 2501-1724



EAT SLEEP RIDE

Navy Snapback

C/Note # 20024-015-01 PU #: 2501-1728

CASUAL



OG HATS

Black Flexfit

S-M: # 20011-001-17 PU #: 2501-1550
L-XL: # 20011-001-18 PU #: 2501-1551



CORPO

Black Snapback

Colored logo: #20015-013-01 PU #: 2501-1596



Black Snapback

White logo: # 20015-001-01 PU #: 2501-1595



ICON HATS

Red 210 Fitted

S-M: #20014-003-17 PU #: 2501-1591
L-XL: #20014-003-18 PU #: 2501-1592



Black 210 Fitted

S-M: #20014-001-17 PU #: 2501-1589
L-XL: #20014-001-18 PU #: 2501-1590



Navy 210 Fitted

S-M: #20014-015-17 PU #: 2501-1593
L-XL: #20014-015-18 PU #: 2501-1594



INDIAN DUNES

Navy

20102-015-01 PU #: 2501-1599



INDIAN DUNES

Red

20102-003-01 PU #: 2501-1598



GASLAMP BEANIE

Grey

20101-007-01 PU #: 2501-1597

CASUAL



OLD SCHOOL *Black T*

M: # 32001-001-11 PU #: 3030-8234
 L: # 32001-001-12 PU #: 3030-8235
 XL: # 32001-001-13 PU #: 3030-8236
 XXL: # 32001-001-14 PU #: 3030-8237
 XXXL: # 32001-001-15 PU #: 3030-8238



OLD SCHOOL *Heather Grey T*

M: # 32001-007-11 PU #: 3030-8239
 L: # 32001-007-12 PU #: 3030-8240
 XL: # 32001-007-13 PU #: 3030-8241
 XXL: # 32001-007-14 PU #: 3030-8242
 XXXL: # 32001-007-15 PU #: 3030-8243



VINTAGE *White T*

M: # 32002-000-11 PU #: 3030-8389
 L: # 32002-000-12 PU #: 3030-8390
 XL: # 32002-000-13 PU #: 3030-8391
 XXL: # 32002-000-14 PU #: 3030-8392



SPEEDLAB *Red Standard T*

M: # 32005-000-11 PU #: 3030-8401
 L: # 32005-000-12 PU #: 3030-8402
 XL: # 32005-000-13 PU #: 3030-8403
 XXL: # 32005-000-14 PU #: 3030-8404
 XXXL: # 32005-000-15 PU #: 3030-8405



EFFORT *Dark Navy Heather Premium T*

M: # 32004-000-11 PU #: 3030-8397
 L: # 32004-000-12 PU #: 3030-8398
 XL: # 32004-000-13 PU #: 3030-8399
 XXL: # 32004-000-14 PU #: 3030-8400



XEROX *White Premium T*

M: # 32003-000-11 PU #: 3030-8393
 L: # 32003-000-12 PU #: 3030-8394
 XL: # 32003-000-13 PU #: 3030-8395
 XXL: # 32003-000-14 PU #: 3030-8396



ICON *Black Premium T*

M: # 32006-000-11 PU #: 3030-8406
 L: # 32006-000-12 PU #: 3030-8407
 XL: # 32006-000-13 PU #: 3030-8408
 XXL: # 32006-000-14 PU #: 3030-8409



CLASSIC *Black Hoody*

M: #36001-001-11 PU #: 3050-1983
 L: # 36001-001-12 PU #: 3050-1984
 XL: #36001-001-13 PU #: 3050-1985

XXL: #36001-001-14 PU #: 3050-1986
 XXXL: #36001-001-15 PU #: 3050-1987

CASUAL



FILLMORE *Heather Natural*

CNew S: # 32007-058-10 PU #: 3030-9091
 M: # 32007-058-11 PU #: 3030-9092
 L: # 32007-058-12 PU #: 3030-9093
 XL: # 32007-058-13 PU #: 3030-9094



ASLANT *Navy*

CNew S: # 32008-015-10 PU #: 3030-9095
 M: # 32008-015-11 PU #: 3030-9096
 L: # 32008-015-12 PU #: 3030-9097
 XL: # 32008-015-13 PU #: 3030-9098
 XXL: # 32008-15-14 PU #: 3030-9099



SCRAMBLER *Black*

CNew S: # 32009-001-10 PU #: 3030-9100
 M: # 32009-001-11 PU #: 3030-9101
 L: # 32009-001-12 PU #: 3030-9102
 XL: # 32009-001-13 PU #: 3030-9103
 XXL: # 32009-001-14 PU #: 3030-9104



MERICA *Navy*

CNew S: # 32010-015-10 PU #: 3030-9105
 M: # 32010-015-11 PU #: 3030-9106
 L: # 32010-015-12 PU #: 3030-9107
 XL: # 32010-015-13 PU #: 3030-9108



HEXAGON *Heather Red*

CNew S: # 32011-003-10 PU #: 3030-9109
 M: # 32011-003-11 PU #: 3030-9110
 L: # 32011-003-12 PU #: 3030-9111
 XL: # 32011-003-13 PU #: 3030-9112
 XXL: # 32011-003-14 PU #: 3030-9113



SPIRIT *Charcoal*

CNew S: # 32012-052-10 PU #: 3030-9114
 M: # 32012-052-11 PU #: 3030-9115
 L: # 32012-052-12 PU #: 3030-9116
 XL: # 32012-052-13 PU #: 3030-9117
 XXL: # 32012-052-14 PU #: 3030-9118



LUX *Charcoal Lightweight Zip Hoody*

M: # 36003-052-11 PU #: 3050-1992
 L: # 36003-052-12 PU #: 3050-1993
 XL: # 36003-052-13 PU #: 3050-1994
 XXL: # 36003-052-14 PU #: 3050-1995



CORPORATE *Black Crewneck Sweatshirt*

M: # 36002-001-11 PU #: 3050-1988
 L: # 36002-001-12 PU #: 3050-1989
 XL: # 36002-001-13 PU #: 3050-1990
 XXL: # 36002-001-14 PU #: 3050-1991



JIMMY
DECOTIS



AIR FRESHENER *Red or Yellow*
70999-003-01 PU #: 9904-0934



POSTER PAULIN *15" X 24"*
70102-021-00



DECAL SHEET *8" X 4"*
70000-012-01

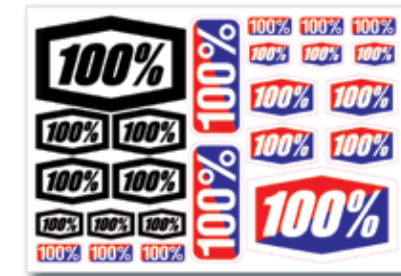

DECAL SHEET *8" X 5 1/2"*
70000-011-01



DECAL SHEET *12" X 18"*
70000-010-01



BANNERS *Small: 28" X 12" Large: 6' X 3'*
Metal Sign: # 70101-000-43
Small Tyvek: # 70100-000-42
Large Vinyl: # 70100-000-40



LANYARD *Standard*
70900-000-01



UMBRELLAS *Standard Premium*
Premium : # 70802-002-00
Standard : # 70801-000-00

▲
WILLY
BROWNING
▼





www.ride100percent.com

Distributed by:



100% and 100% Speedlab are registered trademarks. All rights reserved.
Copyright © 2012. Prices and specifications subject to change without notice.
Reproduction of this catalog without written permission is prohibited.
Printed in the USA.